



king swings



2024 | Vinyl Swing Sets and Playhouses

Since 1988

Table of Contents

2	Index
4	Best Sellers
6	How to Order
7	Quality in Every Detail
8	FAQ & Warranty Info
10	Kingdom Series
30	Space Shuttle Series
40	Pirate Ship Series
56	Teddy Bear Series
66	Custom
68	Towers
70	Playhouses
71	Roofs
72	Connectors
73	Swing Beams
74	Slides
76	Climbers
77	Swings
80	Fun Accessories
82	Mulch, Edging, Weed Guard
83	King Swings Commercial
84	About King Swings
85	Behind The Scenes

Kingdom Series Playhouses

**New for 2024 **

View on Page

10



The Chalet A-Frame

View on Page

12



The Summit A-Frame

View on Page

14



The Hemet Homestead



Kingdom Series Playhouses

View on Page

16



The Homestead

View on Page

18



The Cottage

View on Page

20



The Palace

View on Page

22



The Chateau

View on Page

24



The Mansion

View on Page

26



The Lodge

View on Page

28



The Bungalow

Space Shuttle Large Series

View on Page

30



Rocket Launcher

View on Page

32



Space Walk

View on Page

34



The Eclipse

View on Page

36



The Galaxy

View on Page

38



Launching Pad

View on Page

40



Cosmic Launcher

Pirate Ship Medium Series

View on Page

42



Captain's Castle

View on Page

44



Sea King

View on Page

46



Wave Rider

View on Page

48



Starboard Escape

View on Page

50



Captain's Pearl

View on Page

52



Treasure Cove

View on Page

54



The Marina

Teddy Bear Small Series

View on Page

56



Cubby's Fort

View on Page

58



Care Bear Castle

View on Page

60



Winnie's Tower

View on Page

62



Honey Bear Hangout

View on Page

64



Wish Bear's Dream



Best Sellers

Not sure where to start? With so many options, sizes, and colors, it can seem a bit overwhelming. A great place to start is our best sellers since they show our most popular towers, slides, and accessories.

The Sea King

Pirate Ship Series | Medium

With plenty of room in the 6x8 tower for the fun adventures your children embark on, the Sea King also has the components to take those adventures to the next level. A full width rock wall, staircase, waterfall slide, and 3 position monkey bar provides both easy access to the tower and fun challenges!

[View on Page 44](#)



Cubby's Fort

Teddy Bear Series | Small

The Cubby's Fort is a best seller year after year! It is a classic swing set design in an attractive package. It has everything you need in a tight layout that will fit into almost any backyard while not breaking the budget!

[View on Page 56](#)



The Cottage

Kingdom Series | Playhouse

The Cottage is our best selling playhouse swingset. It is big enough to feel spacious, but not so big it dominates the space. The lean-to-roof lends a modern feel to classic swing set design. The access point is stairs making it accessible for parents, big kids, little kids, and even pets. An avalanche slide and 3 position swing beam round out the set.

[View on Page 18](#)



The Captain's Castle

Pirate Ship | Medium

Striking to behold, the Captain's Castle boasts a full width 7' rock wall on the back of the tower, a 7' spiral slide, waterfall slide, hammock swing, and three position monkey bar swing beam. The Captain's Castle has fun options for both younger and older children.

[View on Page 42](#)



Honey Bear Hangout

Teddy Bear | Small

The Honey Bear Hangout is great for smaller backyards. It has all the classic swing set components, but does not take up a lot of space. The monkey bar swing beam provides a tremendous physical challenge. The tower includes a waterfall slide and a telescope. Three swing beam positions are included in the standard set.

[View on Page 62](#)



How to Order

1



Measure & Familiarize

Know your yard and check out our swing sets at kingswingsets.com

2

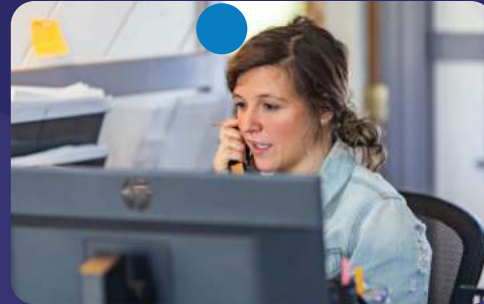

Customize & Order

Contact our design team to customize your swing set and place a deposit.

See more on Page 60

3



Scheduling & Installation

We will line up a day for our crew to deliver and install your set. Most sets are ready for play within 1 to 3 hours.

4



Play Time!

Our playsets are ready to be played on as soon as the crew is done!

Quality in Every Detail



We get it, a swing set is a big purchase, and we want you to be confident in your choice. We use the highest quality materials and products in the manufacturing of our swing sets. Nearly all of our materials are sourced from right here in the USA and we build each set by hand from the ground up.

FAQ

Q1: What if my yard has a bit of a slope?

We can work with a slope of 12" over 20'. If you have a slope, we will need to dig down and/or block up the tower to stabilize it

Q2: What are the color options?

For the vinyl on your swing set, you can choose ivory with brown decking or bright white with gray decking. Playhouse walls can be white, ivory, red, blue, green, black, gray, Most swings, slides, and climbers can be available in blue, red, gray, and green.

Q3: Does customizing cost extra?

No. We love to help parents design their own swing set so there is no cost for customizing. The cost only changes as you remove or add components.

Q4: How easy is vinyl to clean?

Very easy. Just spot wash as needed with a simple cleaner or give it a power washing.

Q5: Where do you deliver and install?

We deliver and install to the lower 48 states. Contact our team to learn when we can deliver to you!

Q6: What surfaces can the swing set be installed on?

King Swings installs on grass, sand, gravel, dirt, turf, concrete (assuming you will add playground surfacing), and mulch. We offer several mulch options that can be installed at the same time as the set. (see page 82)



Why King Swings?



Premium Materials

Trex decking, Georgia Yellow Pine, stainless steel hardware, and more withstand children, weather, and most importantly, time.

Exceptional Craftsmanship

The artisans at King Swings take pride in their work and craft the highest quality swing sets. We take a personalized approach to every swing set we build, which allows for the customization of our product.

Highest Safety Standards

From materials to construction, children's safety is our #1 priority when crafting and installing our sets. Our design team will ensure you pick an age-appropriate set that grows with your kids that is installed in a safe area of your yard.

Best in Class Warranty

We stand behind our work. The vinyl has a 20-year warranty against discoloration and fading, and the swing set has a 6-year warranty on all parts & artistry.

Top-Rated Customer Service

From sales to delivery and installation, we earn 5-star reviews from our customers on Google. Efficient, simple process, polite, and hardworking is just some of positive feedback received.

Model Includes

Towers: 6' x 6' Playdeck w/ 6' Deck Height
 Connector: 8' Wobbly Bridge
 Playhouse: 6' x 13' A-Frame Playhouse
 Slides: 7' Turbo Tube, 12' Avalanche Slide
 Climbers: 6' Staircase w/ Aluminum Railing, 6' Full Width Rock Wall, 6' Ladder
 Roof Type: Metal (A-Frame) and Poly (Tower)
 Swing Beam: 3 Position High Beam w/ Perpendicular Monkey Bars
 Rides: Belt Swing, Trapeze Bar, Plastic Glider
 Fun Accessories: 2 Big Playhouse Windows, A-frame Playhouse Balcony with crawl space, Aluminium Railing, 4' x 11' Porch, Decking under the tower

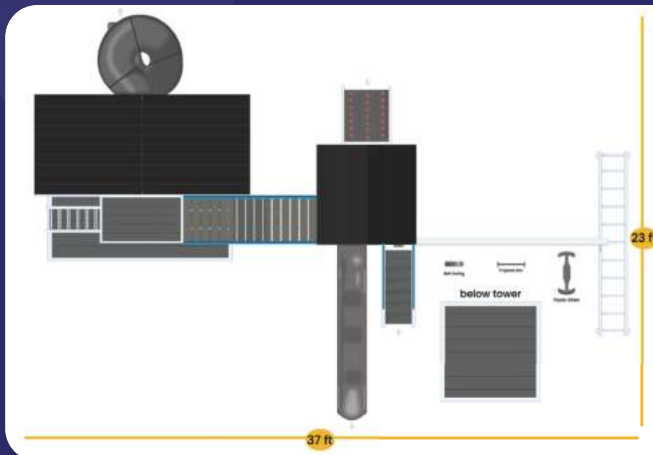

Border
 144 Linear ft.
 Rubber Mulch
 4 tons
 Wood Mulch
 12 cu. yds.
 Weed Guard
 1247 sq. ft.
 Total Space
 29' x 43'
 Total Height
 12' 5"



The Chalet

Recommended Ages 4 to 12



Customizing Tip

The second tower has many customization options - add climbers or slides or even a ball pit under the tower. Big windows can be added to the back of the A-Frame playhouse to allow for more light.

Model Includes

Playhouse: 6' x 13' A-Frame Playhouse

Roof Type: Metal A-Frame

Fun Accessories: 4' x 11' front porch, 2 Big Playhouse Windows, Tea Table and 2 Chairs

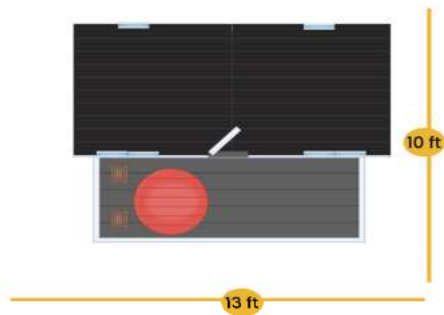

Border
70 Linear ft.
Rubber Mulch
1 ton
Wood Mulch
3 cu. yds.
Weed Guard
304 sq. ft.
Total Space
16' x 19'
Total Height
12' 5"



The Summit

Recommended Ages 2 to 12



Customizing Tip

Add a second story playhouse by adding a balcony. Include a slide out the back which can be accessed through the crawl space. You can also connect a second tower with a bridge from the balcony.

Model Includes

Playhouse: 6' x 8' Playhouse

Towers: Ground Level 8' x 11' Playdeck

Roof Type: Metal Lean-to-Roof

Fun Accessories: Coffee bar w/ 2 Chairs, Aluminum Railing, 2 Big Playhouse Windows, Additional Playhouse door

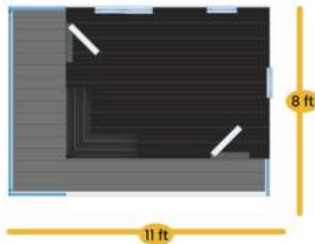

Border
62 Linear ft.
Rubber Mulch
1 ton
Wood Mulch
3 cu. yds.
Weed Guard
238 sq. ft.
Total Space
14' x 17'
Total Height
7' 10"



The Hemet Homestead

Recommended Ages 2 to 10

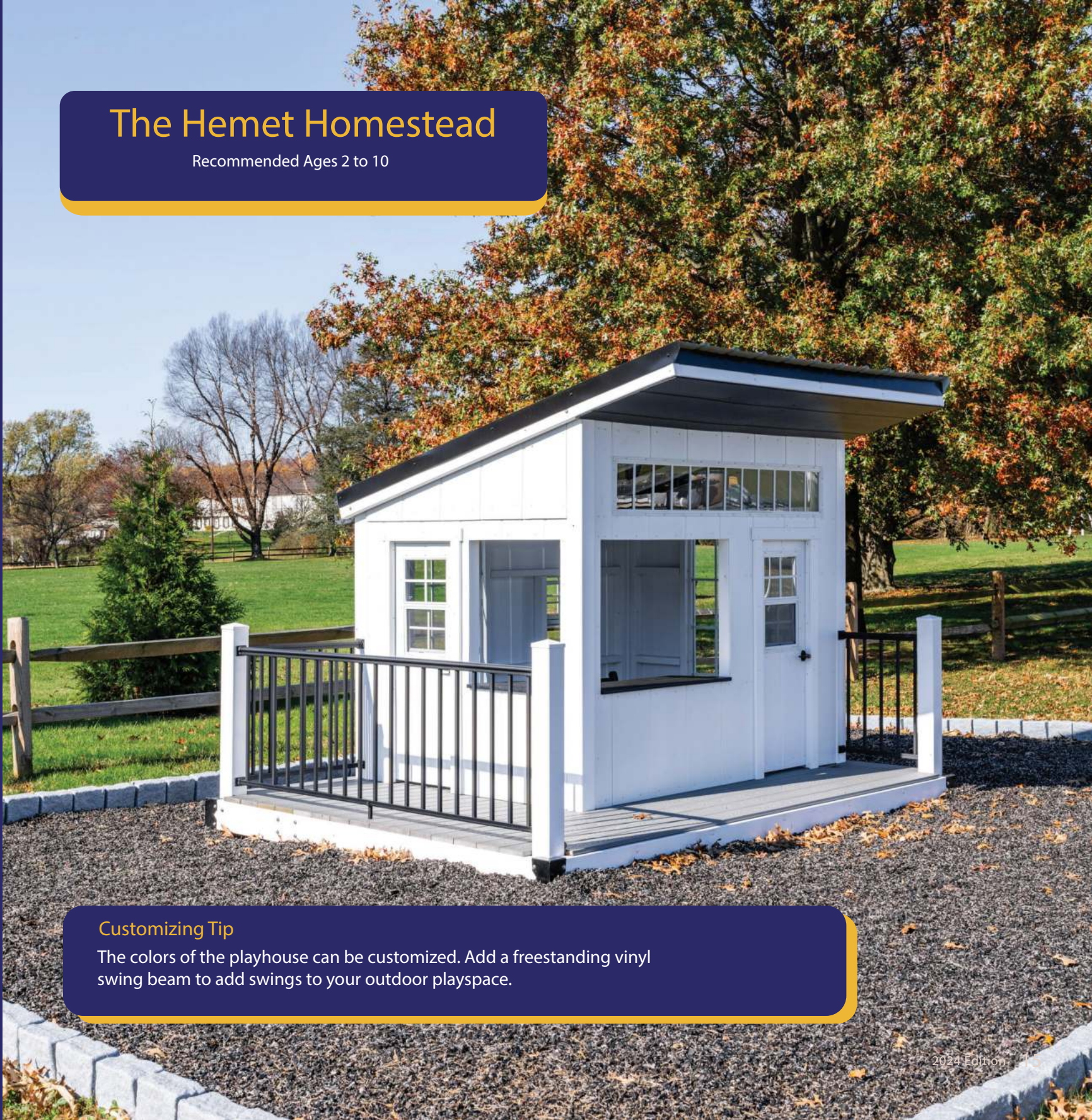

Customizing Tip

The colors of the playhouse can be customized. Add a freestanding vinyl swing beam to add swings to your outdoor playspace.

The Homestead

Recommended Ages 3 to 14



Customizing Tip

Replace the bubble tube panel with a tunnel express slide and add a turbo tube slide out the back of the playhouse. Adding a rock wall to the front of the playhouse provides a fun climbing experience!

Model Includes

Towers: 8' x 11' Play Deck with Aluminum Railings w/ 6' Deck Height
 Playhouse: 8' x 8' Playhouse, 8' x 8' Clubhouse with (2) Doors
 Slides: 7' Sidewinder
 Climbers: Staircase with Aluminum Railings
 Roof Type: Metal Lean-to Roof
 Swing Beam: 3 Position 10' High Beam
 Rides: 2 Belt Swings, Trapeze Bar
 Fun Accessories: 2 Big Playhouse Windows, 5 Small flower boxes, Coffee Bar with 2 Chairs, Bubble Tube Panel

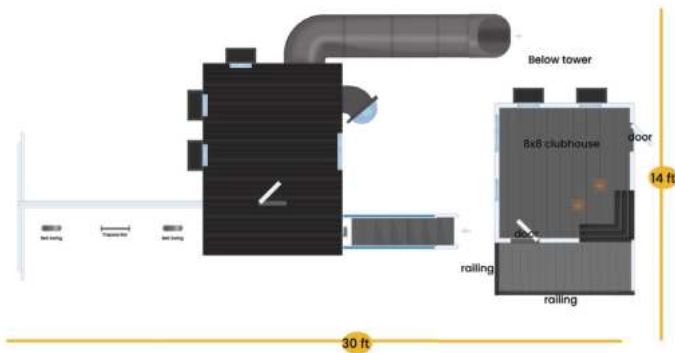

Border
 112 Linear ft.
 Rubber Mulch
 2.5 tons
 Wood Mulch
 7 cu. yds.
 Weed Guard
 720 sq. ft.
 Total Space
 20' x 36'
 Total Height
 14' 1"



Model Includes

Towers: 6' x 8' Play Deck w/ 5' Deck Height

Playhouse: 6' x 6' Playhouse

Slides: 10' Avalanche Slide

Climbers: 5' Staircase

Roof Type: Poly and Metal Lean-to Roof

Swing Beam: 3 Position Monkey Bar

Rides: Plastic Glider, Belt Swing, Trapeze Bar

Fun Accessories: Ship's Wheel, Telescope

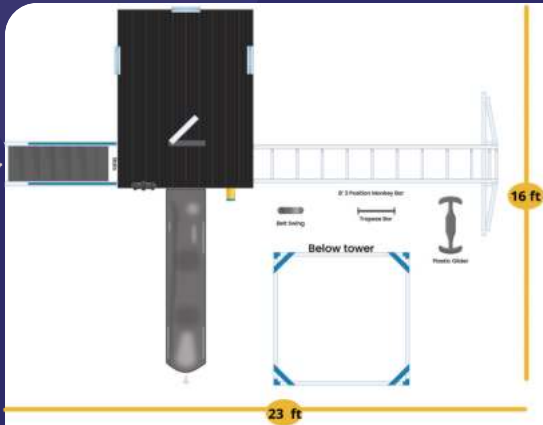

Border
102 Linear ft.
Rubber Mulch
2 tons
Wood Mulch
7 cu. yds.
Weed Guard
638 sq. ft.
Total Space
22' x 29'
Total Height
12' 3"



The Cottage

Recommended Ages 2 to 10



Customizing Tip

Color is a popular way to customize the best selling playhouse. Additionally, add slides out of the playhouse to give the set versatility.

The Palace 2024

Recommended Ages 3 to 12



Customizing Tip

Swap the fireman's pole with a 12' avalanche slide out the front balcony. Add decking under the tower with a picnic table or tea table and chairs to create another play area.

Model Includes

Towers: 8' x 11' Play Deck w/ 6' Deck Height
 Playhouse: 8' x 8' Playhouse
 Slides: 7' Turbo Tube Slide
 Climbers: 6' Poly Staircase, 6' Full Width Rock Climbing Wall
 Roof Type: Poly
 Swing Beam: 3 Position 10' High Beam w/ Perpendicular Monkey Bars
 Rides: Belt Swing, Trapeze Bar, Plastic Glider
 Fun Accessories: Fireman's Pole, 2 Flower Boxes

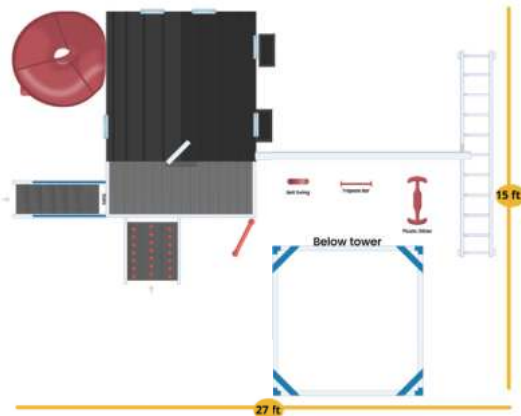

Border
 110 Linear ft.
 Rubber Mulch
 2.5 tons
 Wood Mulch
 7 cu. yds.
 Weed Guard
 714 sq. ft.
 Total Space
 21' x 34'
 Total Height
 14' 6"



Model Includes

Towers: 6' x 8' Play Deck w/7' Deck Height, 4' x 4' Play Deck w/ 7' Deck Height
 Playhouse: 6' x 6' Playhouse
 Connector: Wobbly Bridge
 Slides: 7' Super Spiral Slide, 14' Avalanche Slide
 Climbers: 7' Full Width Rock Climbing Wall, 7' Ladder
 Roof Type: Poly
 Swing Beam: 4 Position 10' High Beam
 Rides: 2 Belt Swings, Buoy Ball, Hammock Swing
 Fun Accessories: 6' x 6' Ball Pit (Includes 2500 Balls), Telescope, Spot Light, Megaphone, Bubble Panel

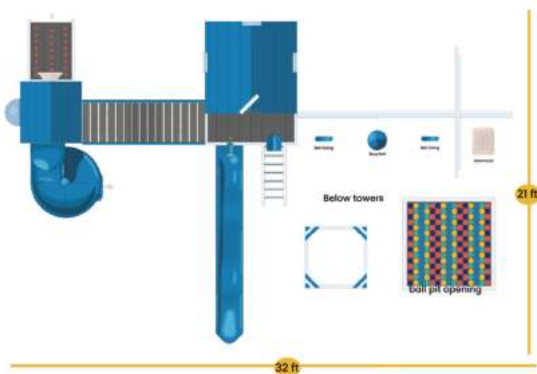

Border
 132 Linear ft.
 Rubber Mulch
 3.5 tons
 Wood Mulch
 10 cu. yds.
 Weed Guard
 1064 sq. ft.
 Total Space
 28' x 38'
 Total Height
 14' 4"



The Chateau

Recommended Ages 4 to 12



Customizing Tip

To make the set toddler friendly, lower the towers down to 5'. Another popular customization is swapping the bubble panel for a fireman's pole.

The Mansion

Recommended Ages 2 to 12



Customizing Tip

Add a climber by moving the slide to the back of the balcony and install the climber next to the staircase. For additional slides, run a sidewinder or turbo tube slide out the back of the Mansion.

Model Includes

Towers: 8' x 8' Play Deck w/ 6' Deck Height
Playhouse: 6' x 6' Playhouse
Slides: 6' Super Spiral Slide
Climbers: 6' Poly Staircase
Roof Type: Poly
Swing Beam: 3 Position High Beam
Rides: 2 Belt Swings, Trapeze Bar
Fun Accessories: Decking under Tower, 8' Lemonade Stand and Chairs, Additional Door, Large Flower Box, Small Flower Box

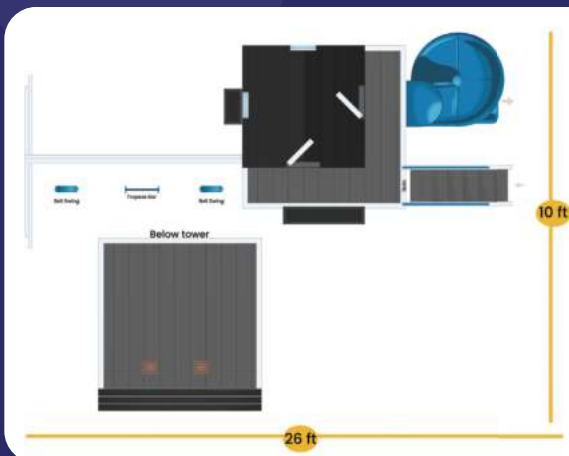

Border Needed
96 Linear ft.
Rubber Mulch
2 tons
Wood Mulch
5 cu. yds.
Weed Guard
512 sq. ft.
Total Space
16' x 32'
Total Height
13'6"



Model Includes

Towers: 6'x 6' Play Deck w/ 5' Deck Height

Playhouse: 4' x 6' Playhouse

Slides: 10' Avalanche Slide

Climbers: 5' Staircase

Roof Type: Poly

Swing Beam: 2 Position Cross Beam

Rides: 2 Belt Swings

Fun Accessories: Built-In Picnic Table

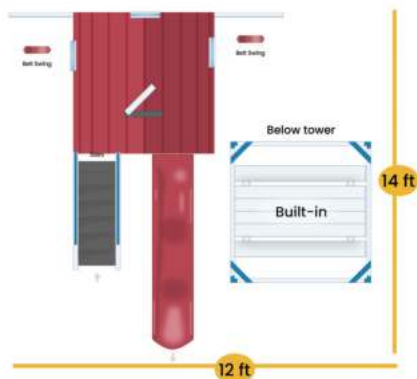

Border Needed

84 Linear ft.

Rubber Mulch

1.5 tons

Wood Mulch

4 cu. yds.

Weed Guard

432 sq. ft.

Total Space

24' x 18'

Total Height

12' 6"



The Lodge

Recommended Ages 2 to 10



Customizing Tip

To add more fun, you could do a tunnel express slide out the back of the playhouse. Swap the picnic table for a ball pit and add a telescope on the railing

The Bungalow

Recommended Ages 2 to 10



Customizing Tip

Adding a ball pit under the tower would max out the fun! A tube slide attached to the back of the tower would add a fun escape hatch!

Model Includes

Towers: 8'x6'Tower, 8'x4' Open Concept Play-house w/ 5' Deck Height

Slides: (2) 10' Waterfall Slides

Climbers: 5' Staircase with Metal Rails

Roof Type: Poly

Swing Beam: 3 Position 8' Standard Swing Beam

Rides: Belt Swing, Trapeze Bar, 2 Rope Tire Swing

Fun Accessories: 2 Spotlights, Fireman's Pole

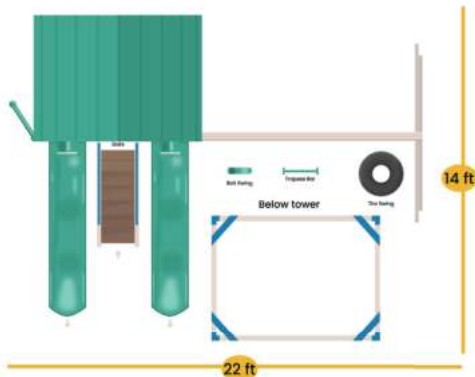

Border
96 Linear ft.
Rubber Mulch
2 tons
Wood Mulch
6 cu. yds.
Weed Guard
560 sq. ft.
Total Space
20' x 28'
Total Height
13' 4"



Rocket Launcher²⁰²⁴

Recommended Ages 2 to 12



Customizing Tip

If you want more climbers, we can change any of the slides to a rock wall or cargo net. Connect a swing beam to the right side to add swings to this set.

Model Includes

Towers: (2) 6 x 12' Double Deck Towers w/ 5' and 7' Deck Heights

Connector: 3' Tunnel Tube

Slides: 7' Turbo Tube Slide, 10' & 14' Avalanche Slides, 5' Sidewinder, 18' Ball Pit Blast

Climbers: 5' Ladder, 5' Full Width Rock Wall, 12' Ramp w/ Poly railing

Roof Type: Poly

Rides: Deluxe Toddler Swing (Below 7' Tower)

Fun Accessories: Ship's Wheel, Telescope, Tic-Tac-Toe, Ball Pit w/2500 playballs, Built-in Picnic Table, Megaphone, Spotlight

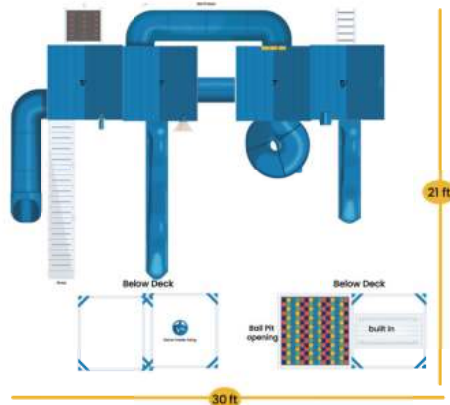

Border
118 Linear ft.
Rubber Mulch:
3 tons
Wood Mulch
9 cu. yds.
Weed Guard
864 sq. ft.
Total Space
28' x 36'
Total Height
13' 2"



Model Includes

Towers: (2) 4' x 4' Play Decks w/ 5' Deck Height
Connector: Wobbly Bridge
Slides: 5' Super Spiral Slide, 10' Waterfall Slide
Climbers: 12' Ramp, 5' Full Width Rock Climbing Wall
Roof Type: Plastic
Swing Beam: 4 Position 8' Standard Beam
Rides: Belt Swing, Deluxe Toddler Swing, Plastic Glider, Hammock Swing
Fun Accessories: Ship's Wheel, Telescope, Tic-Tac-Toe (on Bottom Railing), Lemonade Stand w/ 2 chairs, Decking & Railing Under One Tower

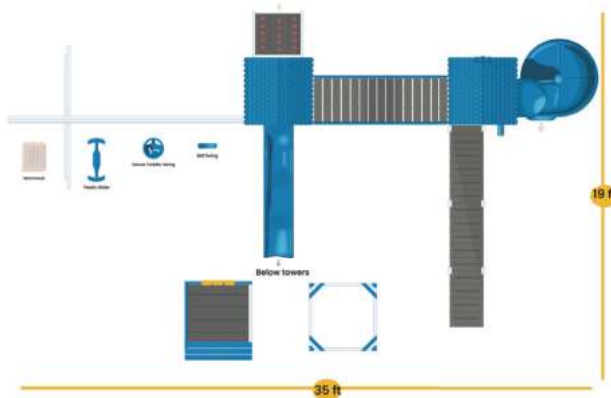

Border
 132 Linear ft.
 Rubber Mulch
 3.5 tons
 Wood Mulch
 10 cu. yds.
 Weed Guard
 1025 sq. ft.
 Total Space
 25' x 41'
 Total Height
 10' 11"



Space Walk

Recommended Ages 3 to 12



Customizing Tip

A common customization is swapping the standard swing beam for a monkey bar swing beam. To make the set more big kid friendly, raise the deck heights to 7' tall, allowing for the addition of taller climbers and faster slides.

The Eclipse

Recommended Ages 2 to 12



Customizing Tip

If you have older children, change the monkey bar to a 10' high beam for higher swinging. Add a hammock swing under the 7' deck. Swap the rock wall for a cargo net.

Model Includes

Towers: 6' x 8' Double Deck w/ 5' & 7' Deck Height

Slides: 7' Turbo Tube Slide, 5' Sidewinder, 10' Avalanche Slide

Climbers: 5' Staircase, 7' Full Rock Wall

Roof Type: Poly

Swing Beam: 3 Position Monkey Bar

Rides: Plastic Glider, Belt Swing, Trapeze Bar

Fun Accessories: Bubble Panel, Tic-Tac-Toe, Ship's Wheel

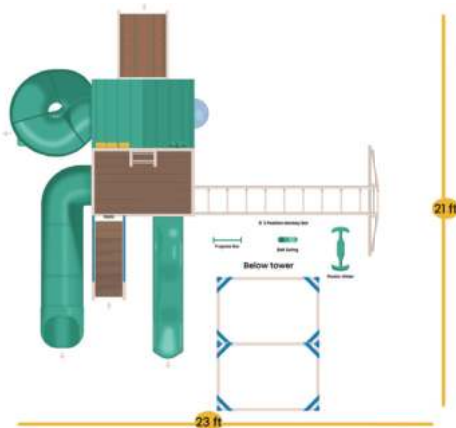

Border
116 Linear ft.
Rubber Mulch
3 tons
Wood Mulch
9 cu. yds.
Weed Guard
841 sq. ft.
Total Space
29' x 29'
Total Height
13' 2"



Model Includes

Towers: Triple Cascade Tower (5', 7', & 9' towers)
Slides: 14' Avalanche Slide, 9' Super Spiral Slide
Climbers: 12' Ramp, 5' Full Width Rock Climbing Wall
Roof Type: Poly
Swing Beam: 4 Position 10' High Beam
Rides: Belt Swing, Trapeze Bar, Plastic Glider, 4 Rope Tire Swing, Hammock Swing (Below 9' deck), Deluxe Toddler Swing (below 7' deck)
Fun Accessories: Ship's Wheel, Telescope, Megaphone, Spot Light, Tic-Tac-Toe, Tea Table and Chairs, Bubble Panel

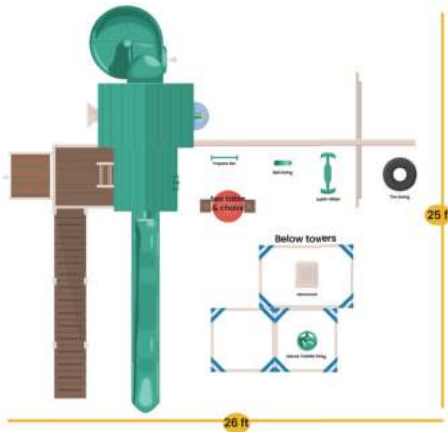

Border
 128 Linear ft.
 Rubber Mulch
 3.5 tons
 Wood Mulch
 11 cu. yds.
 Weed Guard
 1024 sq. ft.
 Total Space
 32' x 32'
 Total Height
 15' 2"



The Galaxy

Recommended Ages 2 to 14



Customizing Tip

For a faster slide, change the super spiral slide to a tunnel express or sidewinder slide.

Add decking to the bottom of the towers to double the play area.

Launching Pad

Recommended Ages 2 to 14



Customizing Tip

Monkey bars can be added by changing the high swing beam to a monkey bar swing beam. Additionally, add a fireman's pole next to the staircase for an extra bit of fun.

Model Includes

Towers: 6' x 8' Double Deck Clubhouse w/ 5' & 7' Deck Height

Slides: 7' Sidewinder, 10' Avalanche Slide

Climbers: 7' Full Width Rock Climbing Wall, 5' Staircase

Roof Type: Poly

Swing Beam: 3 Position 10' High Beam

Rides: Plastic Glider, Belt Swing, Trapeze Bar

Fun Accessories: Tic-Tac-Toe, Telescope, Ship's Wheel



Border
110 Linear ft.
Rubber Mulch
2.5 tons
Wood Mulch
7 cu. yds.
Weed Guard
726 sq. ft.
Total Space
22' x 33'
Total Height
13' 2"



Model Includes

Towers: 4'x8' Double-Deck Tower, 4'x4' Tower with Roof Raised 1', w/ 5' & 7' Deck Height

Connectors: 6' Solid Bridge, 6' Tunnel

Slides: 7' Sidewinder Slide, 7' Turbo Tube Slide, Two 10' Avalanche Slides

Climbers: 7' Cargo Net, 5' Staircase, 5' Ladder

Roof Type: Plastic

Swing Beam: 3 Position 8' Standard Swing beam with Perpendicular Monkeybar

Rides: 3 Belt Swings

Fun Accessories: Decking Under 4'x8' Double-Deck Tower, 8' Additional Railings, Clubhouse with door, 4'x4' Ball Pit w/ 1,500 Balls, 4 Straight Clear Panels, One Elbow Clear Panel

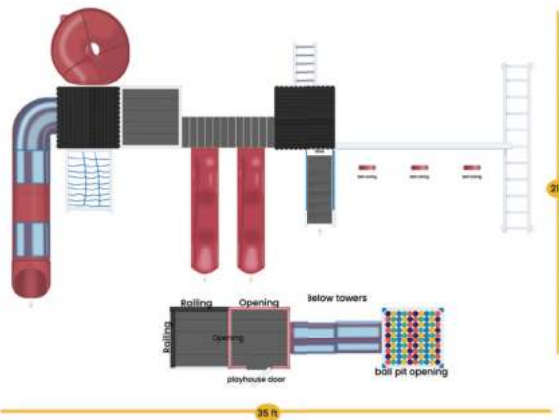

Border
138 Linear ft.
Rubber Mulch
4 tons
Wood Mulch
11 cu. yds.
Weed Guard
1148 sq. ft.
Total Space
28' x 41'
Total Height
12' 6"



Cosmic Launcher

Recommended Ages 2 to 11



Customizing Tip

Additional slides or climbers can be attached to the back side of the bridge. If you need a taller clubhouse, you can also wall up the bottom of the 7' tall tower.

Model Includes

Towers: 4' x 8' Double Deck Tower w/ 5' & 7' Deck Height

Slides: 10' Waterfall Slide, 7' Super Spiral Slide

Climbers: 5' Ladder, 7' Full Width Rock Climbing Wall

Roof Type: Plastic, Pergola

Swing Beam: 3 Position Monkey Bar

Rides: Plastic Glider, Belt Swing, Trapeze Bar,

Hammock Swing (below 7' deck)

Fun Accessories: Tic-Tac-Toe, Telescope



Pictured above is a customized set

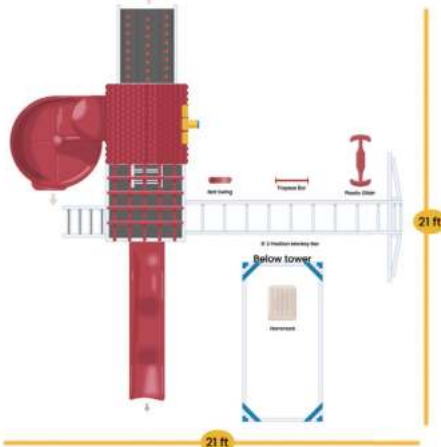

Border
108 Linear ft.
Rubber Mulch
2.5 tons
Wood Mulch
8 cu. yds.
Weed Guard
729 sq. ft.
Total Space
27' x 27'
Total Height
12' 6"



Pictured above is a customized set

Captain's Castle

Recommended Ages 2 to 12



Customizing Tip

Adding a clubhouse under the 7' tower is a great addition to the Captain's Castle. For higher swinging, replace the monkey bar swing beam with a 10' high swing beam and/or add a fourth swing position.

Sea King

Recommended Ages 2 to 10



Customizing Tip

Add a second slide next to existing slide to create a slide racing station! Move the rock wall to the back of the tower and add a super spiral slide in the front.

Model Includes

Towers: 6' x 8' Play Deck w/ 5' Deck Height

Slides: 10' Waterfall Slide

Climbers: 5' Staircase, 5' Full Width Rock Climbing Wall

Roof Type: Poly

Swing Beam: 3 Position Monkey Bar

Rides: Plastic Glider, Belt Swing, Trapeze Bar

Fun Accessories: Tic-Tac-Toe, Ship's Wheel, Telescope

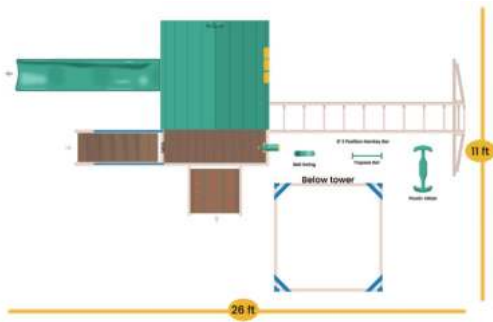

Border
98 Linear ft.
Rubber Mulch
2 tons
Wood Mulch
6 cu. yds.
Weed Guard
544 sq. ft.
Total Space
17' x 32'
Total Height
11' 2"



Model Includes

Towers: 6' x 8' Play Deck w/ 7' Deck Height

Slides: 7' Super Spiral Slide, 14' Avalanche Slide

Climbers: 7' Full Width Rock Climbing Wall, 7' Ladder

Roof Type: Poly

Swing Beam: 4 Position 10' High Beam

Rides: Plastic Glider, Belt Swing, Trapeze Bar,

Hammock Swing, 3 Rope Tire Swing (Below Deck)

Fun Accessories: Telescope, Ship's Wheel

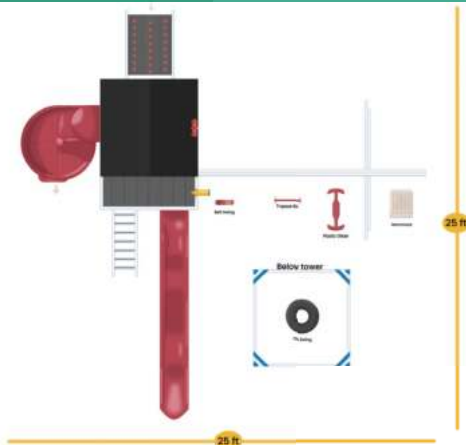

Border
124 Linear ft.
Rubber Mulch
3 tons
Wood Mulch
10 cu. yds.
Weed Guard
961 sq. ft.
Total Space
31' x 31'
Total Height
13' 2"



Wave Rider

Recommended Ages 3 to 14



Customizing Tip

Add decking and a lemonade stand under the tower. Add more climbers by placing a cargo net beside the spiral slide. Perpendicular monkey bars can be added at the end of the swing beam.

Starboard Escape

Recommended Ages 2 to 10



Customizing Tip

Add decking and a lemonade stand under the Starboard Escape gives your children another play area. The standard swing beam can be changed to a monkey bar swing beam.

Model Includes

Towers: 4' x 6' Play Deck w/ 5' Deck Height

Slides: 10' Waterfall Slide, 5' Super Spiral

Climbers: 5' Rock Climbing Wall/Ladder Combo

Roof Type: Plastic

Swing Beam: 3 Position 8' Standard Beam

Rides: Plastic Glider, Belt Swing, Trapeze Bar

Fun Accessories: Tic-Tac-Toe, Telescope

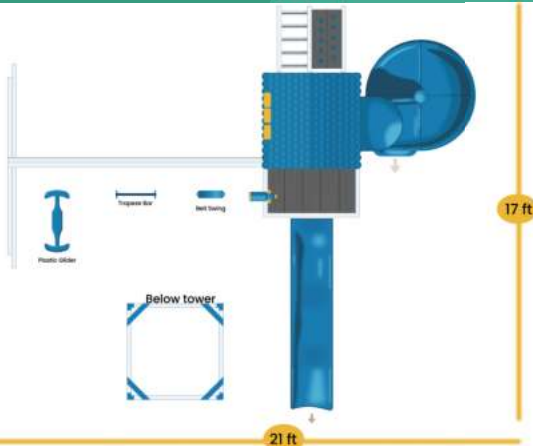

Border
100 Linear ft.
Rubber Mulch
2 tons
Wood Mulch
7 cu. yds.
Weed Guard
621 sq. ft.
Total Space
23' x 27'
Total Height
10' 11'



Pictured above is a customized set

Model Includes

Towers: 6' x 6' Play Deck w/ 6' Deck Height

Slides: 6' Super Spiral Slide

Climbers: 6' Rock Climbing Wall/Ladder Combo

Roof Type: Poly

Swing Beam: 4 Position High Beam

Rides: Plastic Glider, Belt Swing, Trapeze Bar, Hammock Swing

Hammock Swing

Fun Accessories: Decking Under Tower, Ship's Wheel, Telescope, Tea Table & Chairs

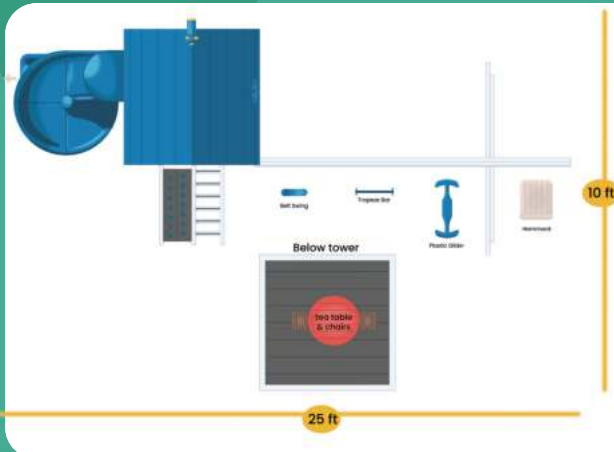

- Border
94 Linear ft.
- Rubber Mulch
1.5 tons
- Wood Mulch
5 cu. yds.
- Weed Guard
496 sq. ft.
- Total Space
16' x 31'
- Total Height
12' 2"



Captain's Pearl

Recommended Ages 3 to 12



Customizing Tip

For an alternative climbing experience, change the combo climber to a ladder and a full width rock wall!

Treasure Cove

Recommended Ages 2 to 10



Customizing Tip

Adding a rock wall to the back of this swing set adds a nice challenge! To make the set even more little-kid-friendly, change the climber to a staircase or ramp.

Model Includes

Towers: 4' x 8' Split Level Play Deck w/ 5' & 6' Deck Height

Slides: 10' Avalanche Slide, 6' Super Spiral Slide

Climbers: 5' Rock Climbing Wall/Ladder Combo

Roof Type: Plastic

Swing Beam: 3 Position Monkey Bar

Rides: Plastic Glider, Belt Swing, Trapeze Bar

Fun Accessories: Decking Under The Tower, Connect Four-in-a-row, Tic-Tac-Toe, Telescope, Ship's Wheel

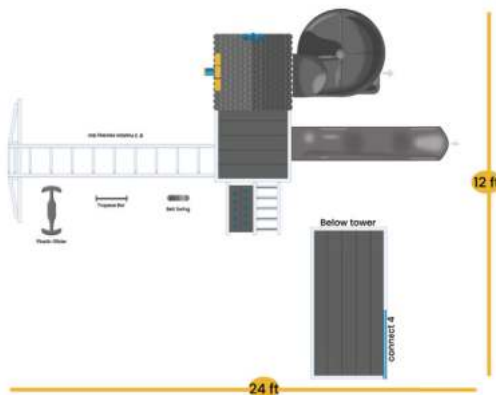

Border
96 Linear ft.
Rubber Mulch
2 tons
Wood Mulch
5 cu. yds.
Weed Guard
540 sq. ft.
Total Space
18' x 30'
Total Height
11' 11"



Model Includes

Towers: 4' x 6' Tower w/ 5' Deck Height

Slides: (2) 10' Avalanche Slides, Ramp Slide

Climbers: 5' Ladder

Roof Type: Poly

Swing Beam: 3 Position 8' Standard Beam

Rides: 2 Belt Swings, Trapeze Bar

Fun Accessories: Decking Under The Tower, Connect Four-In-A-Row, Lemonade Stand (No Chairs), Ship's Wheel

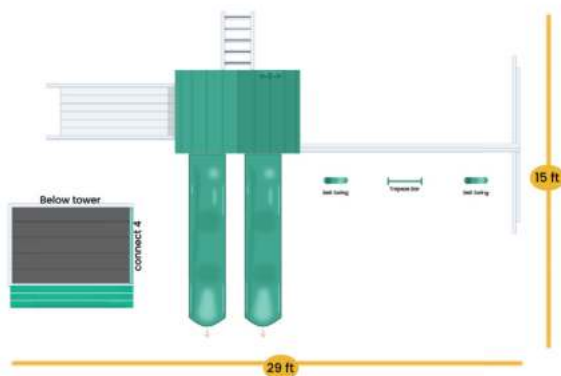

Border

112 Linear ft.

Rubber Mulch

2.5 tons

Wood Mulch

7 cu. yds.

Weed Guard
735 sq. ft.

Total Space
21' x 35'

Total Height
11'2"



The Marina

Recommended Ages 2 to 10



Customizing Tip

To decrease the total space needed, swap the ramp slide for a rock wall, cargo net, or another slide. The swing beam can also be changed to a monkey bar swing beam.

Cubby's Fort

Recommended Ages 2 to 10



Customizing Tip

Swapping the combo climber to a ladder on one side and a full width climber on the back is a great change. To add more swings, change the 3 position monkey bar swing beam to a 4 position!

Model Includes

Towers: 4' x 4' Play Deck w/ 5' Deck Height

Slides: 10' Waterfall Slide

Climbers: 5' Rock Climbing Wall/Ladder Combo

Roof Type: Plastic

Swing Beam: 3 Position Monkey Bar

Rides: Plastic Glider, Belt Swing, Trapeze Bar

Fun Accessories: Telescope, Ship's Wheel, Checkerboard Sandbox Cover



Pictured above is a customized set

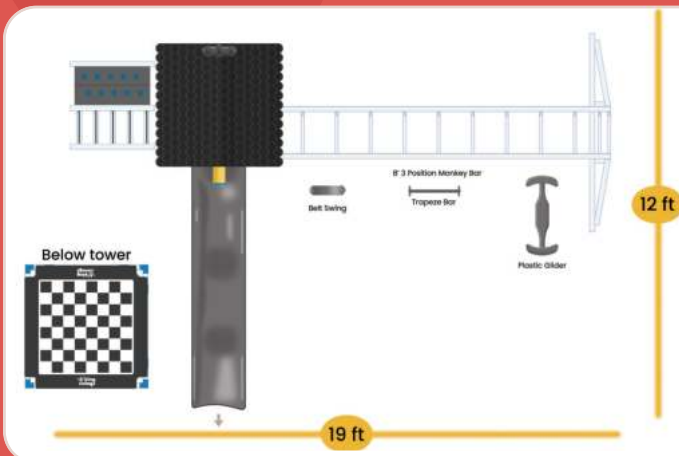

Border
86 Linear ft.
Rubber Mulch
1.5 tons
Wood Mulch
5 cu. yds.
Weed Guard
450 sq. ft.
Total Space
18' x 25'
Total Height
10' 11'



Pictured above is a customized set

Model Includes

Towers: 4' x 4' Play Deck w/ 5' Deck Height

Slides: 10' Waterfall Slide

Climbers: 5' Rock Climbing Wall/Ladder Combo

Roof Type: Plastic

Swing Beam: 2 Position Cross Beam

Rides: 2 Belt Swings

Fun Accessories: Telescope, Ship's Wheel, Tic-Tac-Toe

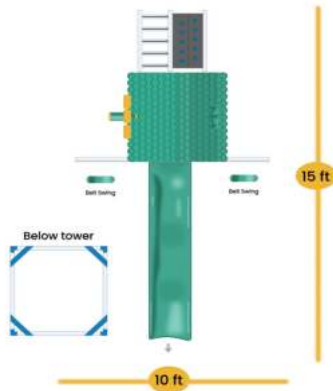

Border
76 Linear ft.
Rubber Mulch
1 ton
Wood Mulch
4 cu. yds.
Weed Guard
352 sq. ft.
Total Space
22' x 16'
Total Height
10' 11'



Care-Bear Castle

Recommended Ages 2 to 10



Customizing Tip

Increasing the deck size to a 6' x 6' provides more space to play up top but still provides a space saving design.

Winnie's Tower

Recommended Ages 2 to 10



Customizing Tip

A rock wall or slide can be added to the back of the tower. The ladder can be swapped for a staircase or ramp!

Model Includes

Towers: 4' x 4' Play Deck w/ 5' Deck Height

Slides: 5' Super Spiral Slide

Climbers: 5' Ladder

Roof Type: Plastic

Swing Beam: 3 Position 8' Standard Beam

Rides: 2 Belt Swings, Trapeze Bar

Fun Accessories: Ship's Wheel

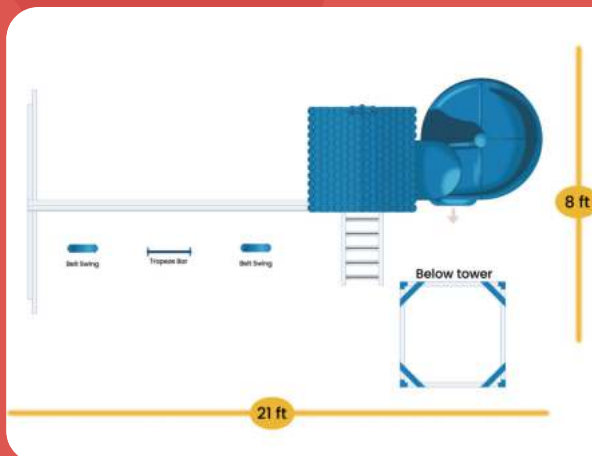

Border
88 Linear ft.
Rubber Mulch
1.5 tons
Wood Mulch
5 cu. yds.
Weed Guard
405 sq. ft.
Total Space
17' x 27'
Total Height
10' 11'



Model Includes

Towers: 2' x 2' Play Deck w/ 5' Deck Height

Slides: 10' Waterfall Slide

Climbers: 5' Ladder

Swing Beam: 3 Position Monkey Bar

Rides: Plastic Glider, Belt Swing, Trapeze Bar

Fun Accessories: Telescope

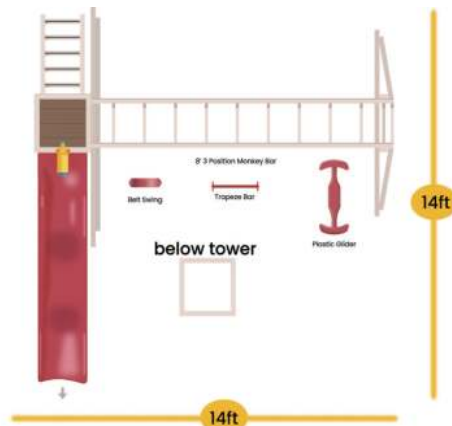

Border
80 Linear ft.
Rubber Mulch
1 ton
Wood Mulch
4 cu. yds.
Weed Guard
400 sq. ft.
Total Space
20' x 20'
Total Height
9'



Honey Bear Hangout

Recommended Ages 2 to 10



Customizing Tip

Adding a fireman's pole or a half width climber to the left side of the tower is a great way to add some fun. If you don't want monkey bars, change to a standard swing beam and/or add a 4th swing position.

Wish-Bear's Dream

Recommended Ages 2 to 10



Customizing Tip

Change one or both of the swing beams to monkey bar swing beams. Additionally, swings can be added by including a fourth swing position to one side or both!

Model Includes

Towers: 2' x 2' Play Deck w/ 5' Deck Height

Slides: 10' Waterfall Slide

Climbers: 5' Ladder

Swing Beam: (2) 3 Position 8' Standard Beams

Rides: Plastic Glider, 3 Belt Swings, Trapeze Bar, Deluxe Toddler Swing

Fun Accessories: Telescope

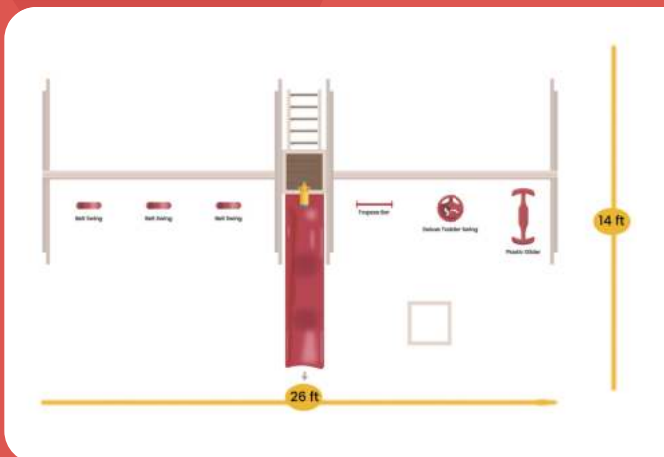

Border
104 Linear ft.
Rubber Mulch
2 tons
Wood Mulch
7 cu. yds.
Weed Guard
640 sq. ft.
Total Space
20' x 32'
Total Height
9'



Customizing

All of our sets are made-to-order, allowing them to be customized.

Customizing is free and our swing set designers work with you to design your set!

Most customers take one of our standard sets and tweak the design till it's just right. Some, however, start from scratch and build their own epic swing set.

If that sounds like you, here are the steps to take!



Familiarize

Browsing our products will give you a good idea of how all of our components work together.



Prioritize

Decide what are the most important features for you. This will guide the process.



Visualize

Draw out your plan! Even a poor drawing is helpful. If you need some help on the layout, do the next step!



Contact

Call, email, or chat with us. Our team will look over your design and help you refine your swing set.



Finalize

The last step is picking your colors and then placing a deposit over the phone.





Towers

Our standard tower height is 5' tall. All towers can be raised or lowered depending on your needs.

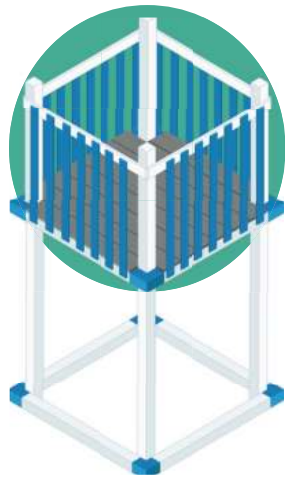

4x4 Tower
The classic size tower

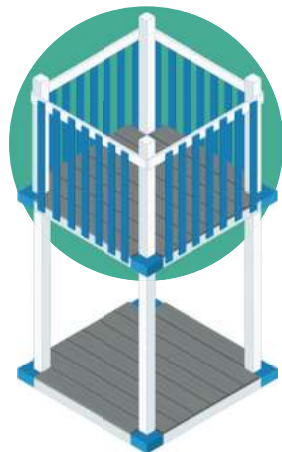

Decking Under Tower
Great for chairs, tables,
or outside toys



4x6 Tower
A nice upgrade
4x4 base w/ 2' balcony

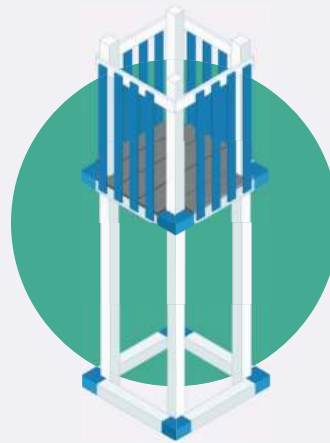

2x2 Tower
Space saving for the
small yard

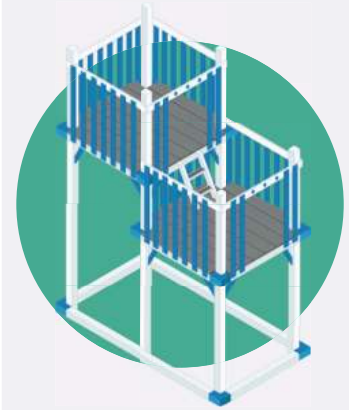

6x12 Double Deck
The classic double deck
tower, with more room.
5' and 7' deck height

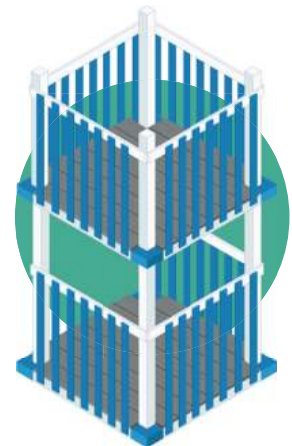

Rails Around Bottom Deck
Perfect for adding flair to the set



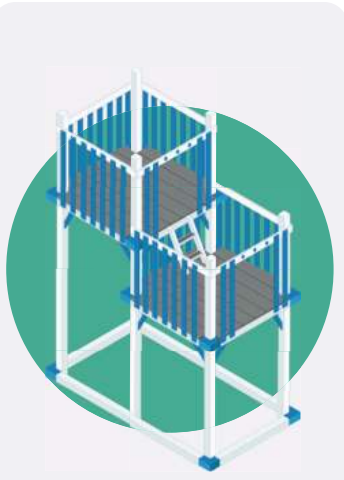

4x8 Double Deck
The classic double deck tower
5' and 7' deck height

◆ ◆



4x8 Split Deck
A double deck for smaller children
5' and 6' deck heights

◆ ◆



6x8 Double Deck Clubhouse
The clubhouse doubles the fun
5' and 7' deck height

◆ ◆



6x6 Tower
Spacious and roomy

◆ ◆



6x8 Double Deck
More room for lots of kids
5' and 7' deck height

◆ ◆

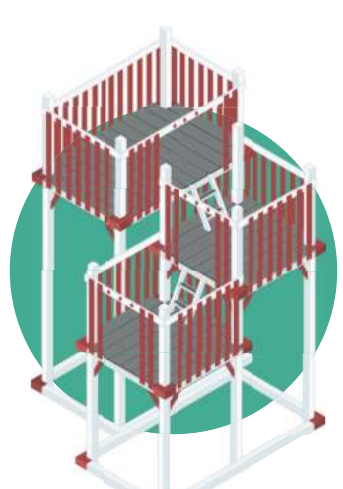

Triple Cascade
5'; 7'; and 9' tall towers

◆ ◆

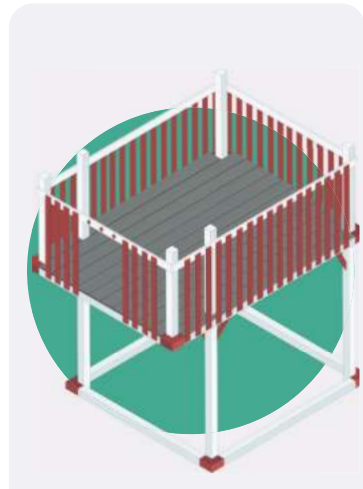

6x8 Playdeck
The largest single tower we offer

◆ ◆

Playhouses

Getting started with playhouses.



FAQ's

- ◆ Playhouse sets are very heavy. We will use a mini skid steer to maneuver the set into place. If the yard is soft or has tight turns, scuffs could be left in the yard. This will be understood as an acceptable risk of installing the swing set.
- ◆ Bright white will show any mud from the road, bug splatters, or other dirt from the manufacturing and delivery process. A simple scrubbing with a cloth and cleaner will remove the dirt from your playset.
- ◆ The size of the playhouse is determined by measuring across the tower the playhouse sits on. The dimensions of the playhouse are approximate.
- ◆ Our playhouses are available in the following sizes: 4' x 6', 6' x 6', 8' x 6', 8' x 8'
- ◆ All playhouses come with 5' tall walls, and the tower they sit on can be 5', 6', or 7' tall.
- ◆ Playhouses require level land for optimal installation and use. Playhouses are not waterproof.

We recommend watching our playhouse product videos on YouTube and browsing our standard sets. If you have questions, contact the swing set design team.

Roofs



Poly Roof

Classic look



Pergola Roof



Plastic Roof

Durable and cute
with a shingled look



Lean-to Roof

A modern roof for a
modern look



Connectors

Connecting towers is a great way to double the fun! From tunnels to bridges, your kids will have a blast running from tower to tower.



Tunnel

Add a bit of challenge
Available in 3', 6', and 9'.



Wobbly Bridge

Wobbly, bouncy fun!
Available in 8'



Solid Bridge

Available on 4', 6', 8',
10', and 12'



Drop Tunnel Connector

The perfect escape hatch. Shown
with optional clear panel.



Swing Beams

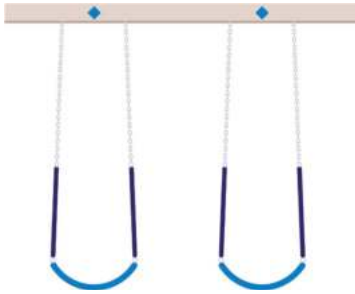

2 Position Cross Beam

Space saving

*as seen on the Care Bear Castle pg. 58

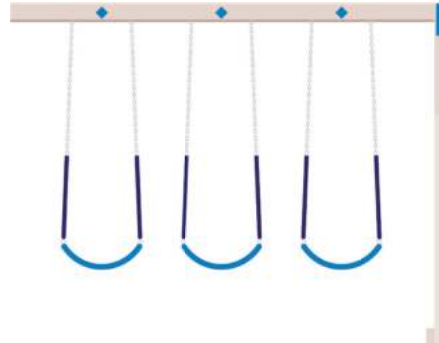

3 Position Beam

The classic swing beam
8' standard beam or 10' high beam

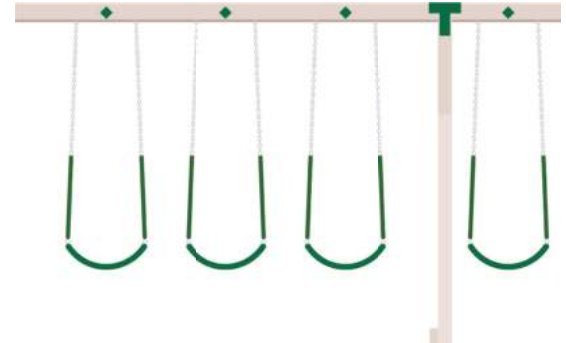

4 Position Beam

Great for hammocks
8' standard beam or 10' high beam



Perpendicular Monkey Bar

Perpendicular monkey bars can be added
to a 3 position 8' or 10' swing beam



3 Position Monkey Bar

Great for swinging and climbing
8' tall, only available on 5' deck heights



4 Position Monkey Bar

Gain an additional swing position
8' tall, only available on 5' deck heights



Slides

Slides are often the first thing you see on a swing set! Most of our popular slides are available on all tower heights!



Waterfall Slide

The classic slide
Available on 5' deck heights only



Super Spiral Slide

Made in Lancaster County
Available on 5', 6', 7', and 9' deck heights



Avalanche Slide

Sturdy and great for younger children
Available on 5', 6', and 7' deck heights





Turbo Tube Slide

Twirly fun
Available on 7' and 9' deck heights



Sidewinder Slide

Flexible placement options
Available on 5', 7', and 9' deck heights

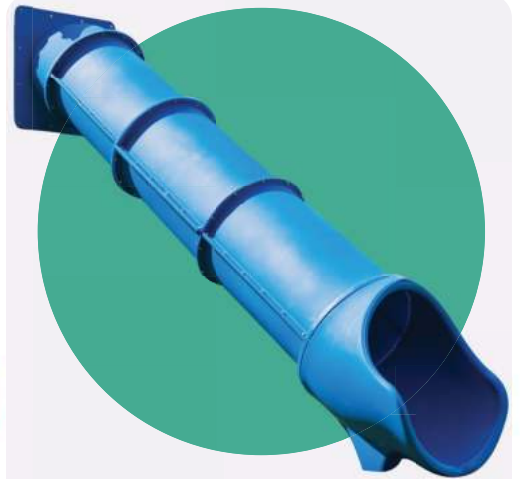

Tunnel Express Slide

The fastest slide
Available on 5', 7', and 9' deck heights



Clear Panels

Available to replace the tops of both
straight tube pieces and curved pieces.



Ball Pit Blast Slide

Connects from 7' deck height to ball pit



Ramp Slide
Available on 5' decks only.



Climbers



Ladder

Space saving and efficient



Staircase

Available on 5' deck height only.



Staircase with Railing

Available on 5', 6', or 7' deck height.



Rockwall / Ladder Combo

Space saving combo



Full Width Rock Climbing Wall

Build strength and coordination



Cargo Net / Ladder Combo

Space saving combo

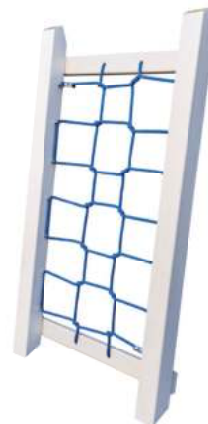

Full Width Cargo Net

A fun climber variant



Ramp

Perfect for little children
Only available with 5' deck
Available with Poly Railings

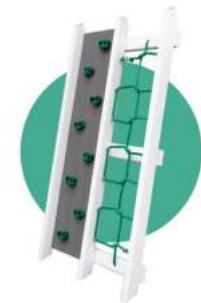

Rock wall/Cargo Net Combo



Swings



Belt Swing

The classic swing.



Deluxe Toddler Swing

Available on all swing positions or under a 6' deck height.



Trapeze Bar

Available on all swing positions or under a 6' deck height.





Daisy Disc

Available on 4th swing position.



Bucket Swing

Available on all swing positions or under a 6' deck height.



Hammock Swing

Available on 4th swing position or under 7' tower.



2 Rope Tire Swing

Fun to sit or stand on



3 Rope Tire Swing

Available under 6'x6' towers or larger.



4 Rope Tire Swing

Great for lots of kids





Plastic Glider

Fun for one, more fun with two



Buoy Ball / Trapeze Combo

Perfect for little monkeys



Buoy Ball

Unique, swinging fun



Fun Accessories

Adding in fun accessories helps spark creative play! A ship's wheel transforms the set into a pirate ship while the spot light adds after dark fun!



Binoculars



Megaphone



Periscope



Telescope



Spotlight



TicTacToe



Steering Wheel



Ship's Wheel



Bubble Tube Panel



Flower Box

Available in small & large



English Garden Bench



Misting System

Available for
Slide & Swing Beam



Big Playhouse Window



Tea Table & Chairs



Checkerboard Sandbox Cover
Available on Tower Sizes 4'x4 or 4'x6'



Picnic Table

4' or 6' table
Available loose & built in



Fireman's Pole



Lemonade Stand

Sized according to Tower Size. Includes 2 chairs.

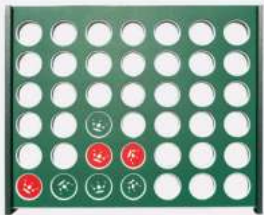

Connect Four-in-a-row



Ball Pit with Balls



Bubble Panel



Coffee Bar & 2
Chairs



Mulch, Edging, Weed Guard



Recycled Rubber Mulch

- Exceptional shock absorbancy
- Reduced risk of playground injuries
- 12 year color guarantee!
- It will not blow away or wash away in storms
- Reduces bug and rodent infestation and does not attract ants
- Will not decompose or compress
- Weather-friendly, never freezes
- Always dry and ready to play almost immediately after even the heaviest rain
- Rainproof, does not retain moisture, slipperiness or dirt
- Our Mulch is 99.9% steel free
- All our products are proudly made in the USA, and are GSA, ASTM, and IPEMA certified.

Wood Mulch

For a traditional play area, we also offer wood mulch. Enjoy a play area like you had when you were a kid!

Beuta Landscaping Edging

Keep your play area neat and tidy with our flexible plastic edging that looks like real stone and installs quickly and easily.

Weed Guard

Keep the weeds outside of your play area with our landscaping screen! Our weed guard comes in wide rolls and can be cut to the desired length of your playground site.



King Swings Commercial creates, delivers, and installs vinyl commercial playgrounds ideal for neighborhood parks, schools, daycares, churches, and more.

Designed and built to meet ASTM codes, our commercial playgrounds are for any application that requires a safety inspection. Our commercial playgrounds are designed by CPSIS inspectors and built to meet ASTM F1487 standards.

With downloadable PDFs, presentations, and clear information, our commercial website will help you get started on your playground project. Our sales team will work with you one on one throughout the process to ensure the set meets your needs and your budget.



About King Swings

Our Story

From our start in an Amish barn in 1988, King Swings has understood the importance of play. Play is foundational in our development from childhood to adulthood.

We are passionate about working alongside you to create the perfect playset for your children! Each set we offer is made-to-order and completely customizable; plus we deliver and install. King Swings is dedicated to helping you bring peace and play to your backyard!

The Team

King Swings is made up of Amish craftsmen from all over Lancaster County. The owner, Elmer, has been in the swing set business his entire life. King Swings has been blessed with a group of solid team members, both in the office and in building bays, who are passionate about safe and fun swing sets.

History

Ben King founded King Swings in 1988 in his barn. Since then, the company has grown, and his son, Elmer, has expanded both production and vision, servicing many states, with plans of further expansion.



Behind The Scenes

Companies, whether big or small, are made up of the same thing; people. King Swings believes we have some of the best people around. From the office clear through to the installation crews, King Swings is proud of our team.

Manufacturing



Delivery & Installation



Sales & Office









Bring the Playground Home



Your Local Dealer

-  Follow us on Facebook
[@kingswings](#)
-  Follow us on Instagram
[@kingswingsplay](#)
-  Follow us on Pinterest
[@kingswingsplay](#)
-  Subscribe on Youtube
[King Swings](#)